

# Procédure

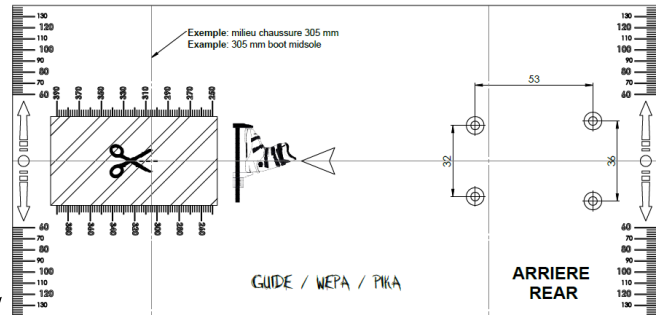

# Instructions

1/2

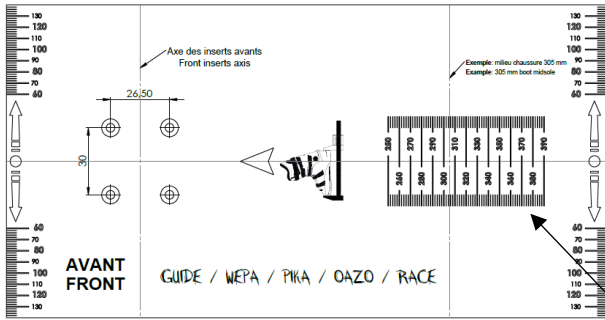

1cm = 1cm

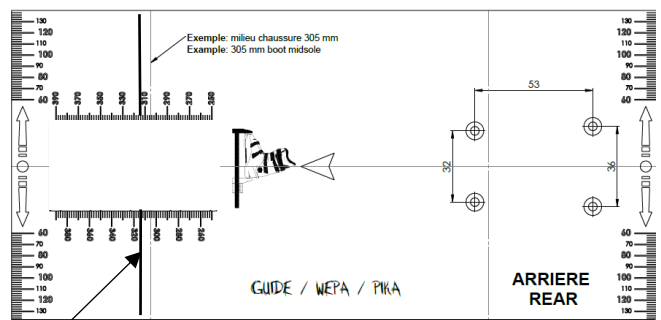
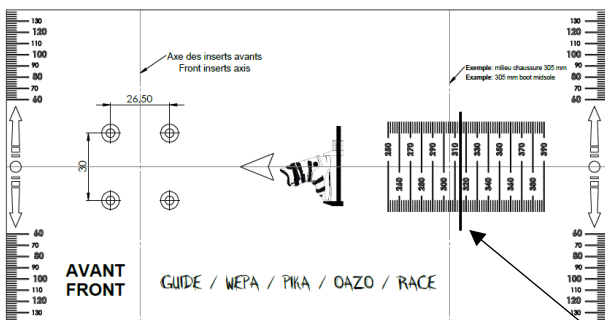
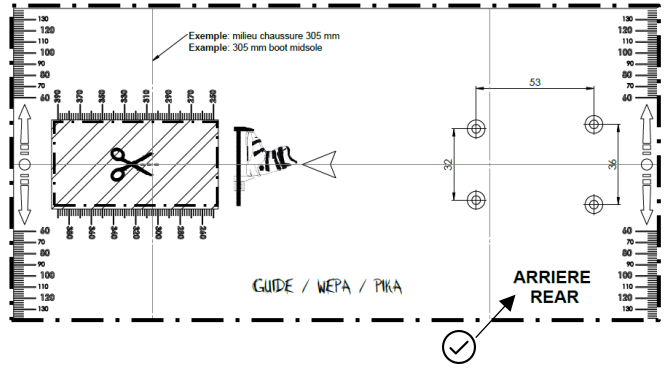
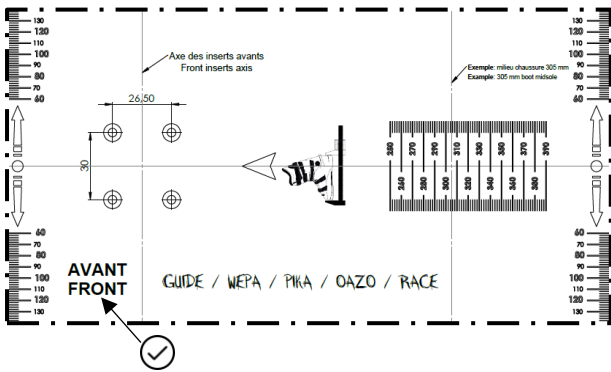
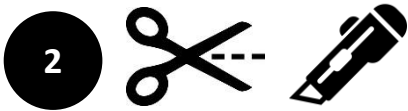

4

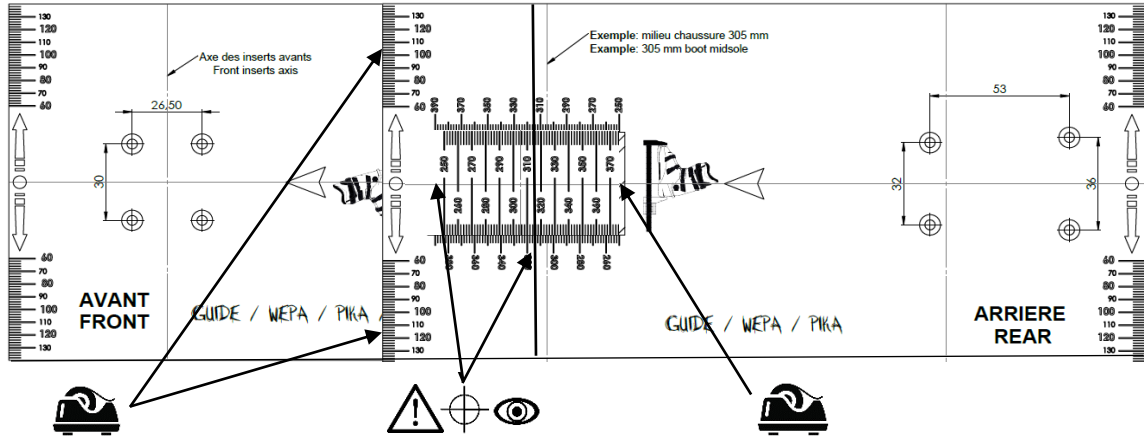
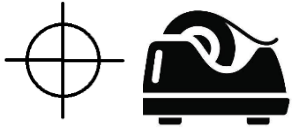

5

