

Procédure

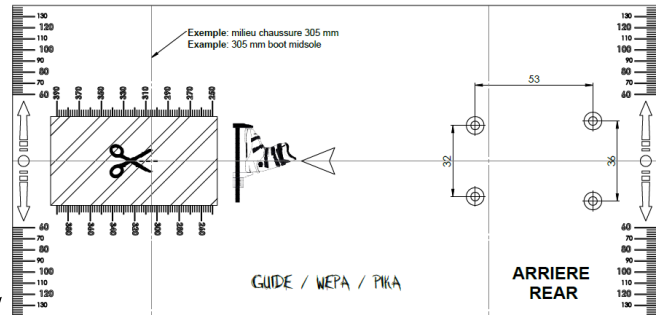

Instructions

1/2

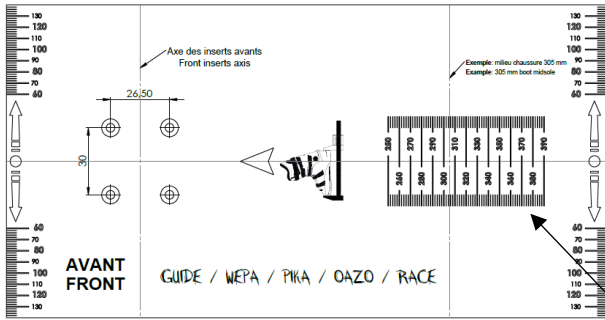

1cm = 1cm

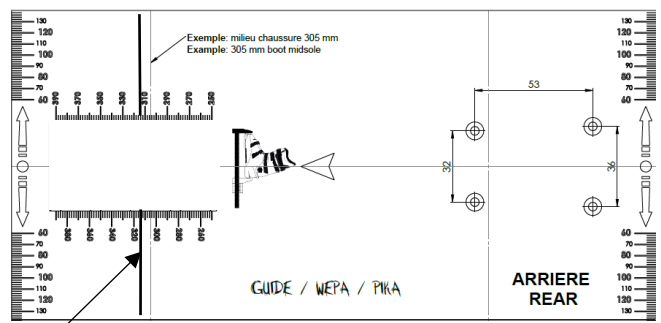
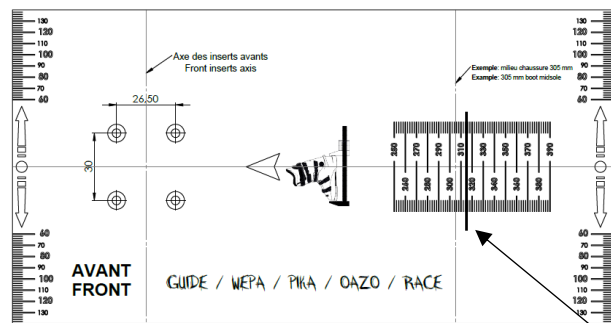
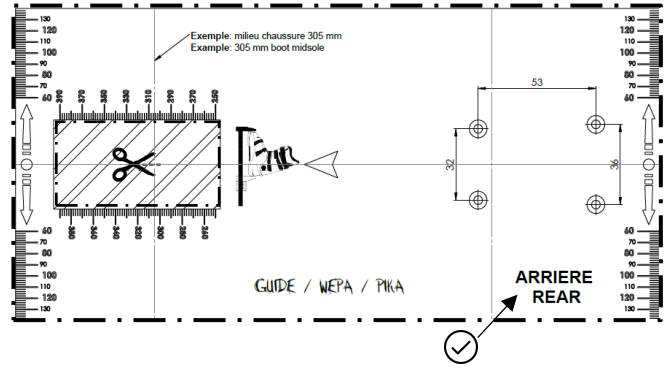
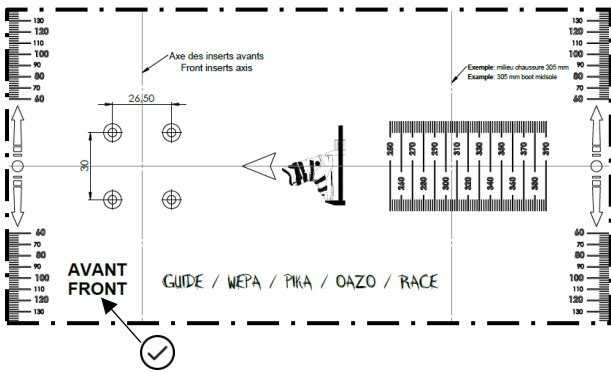

mm

4

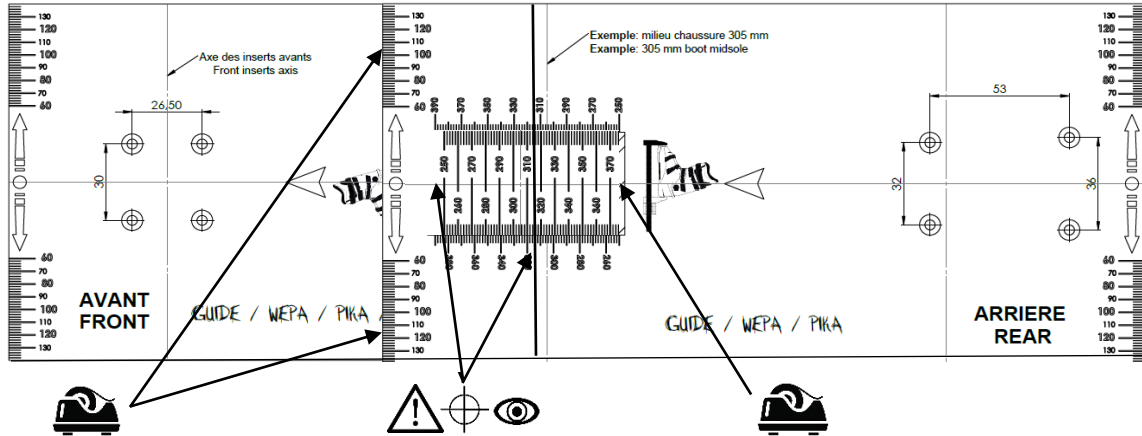
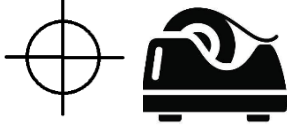

5

