

Procédure

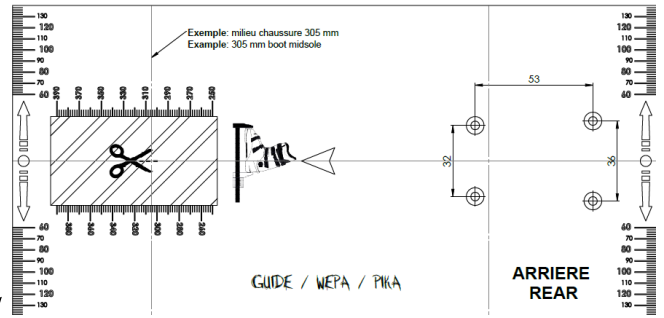

Instructions

1/2

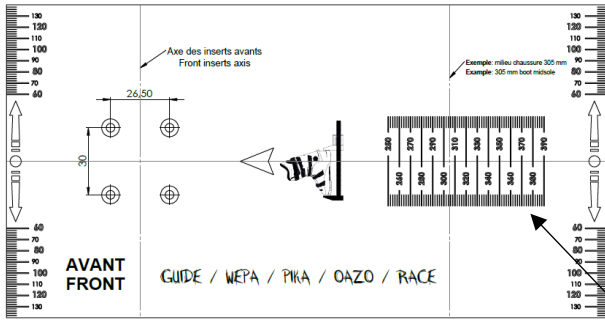

1cm = 1cm

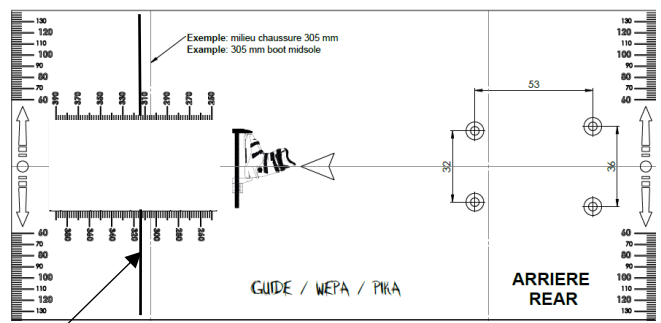
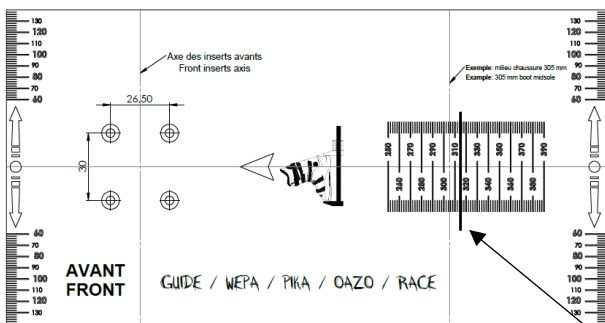
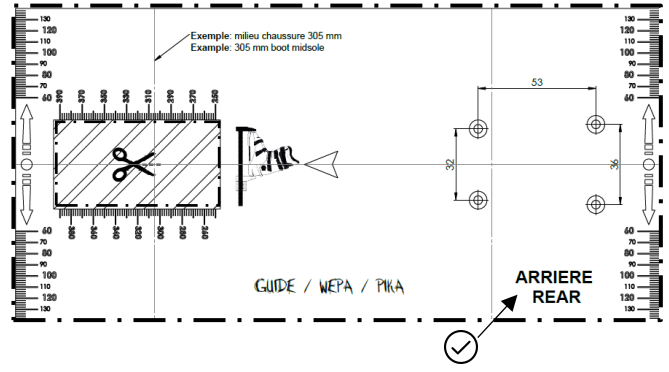
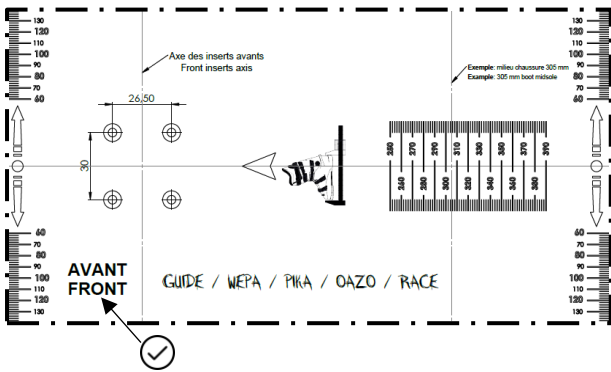
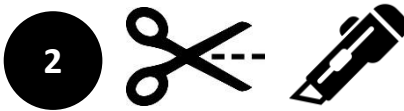

4

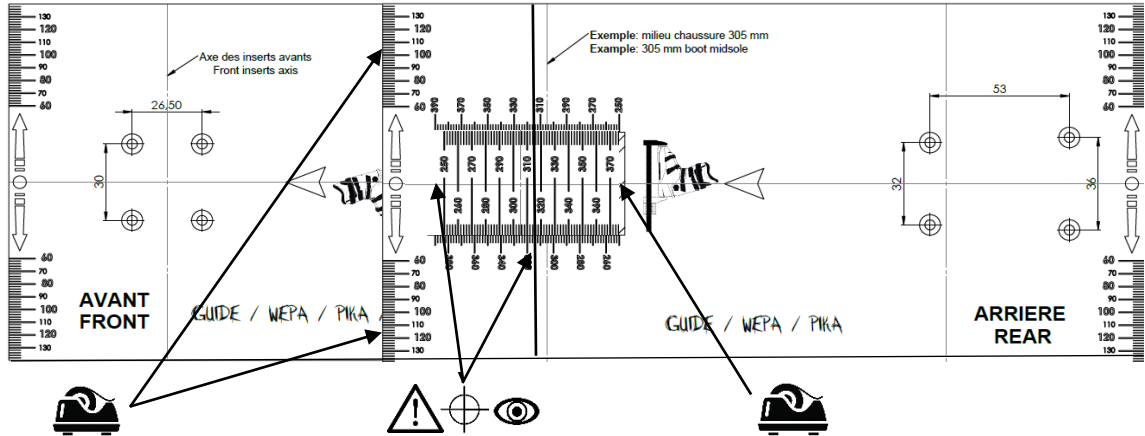
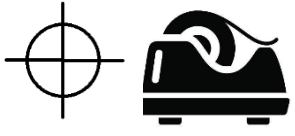

5

