

Exemple: milieu chaussure 305 mm
Example: 305 mm boot midsole

ARRIERE
REAR

Procédure



Instructions

1/2

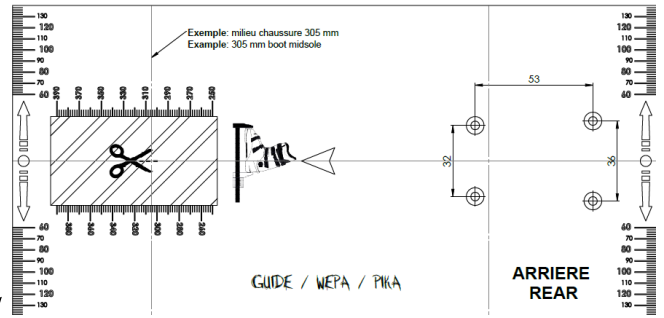
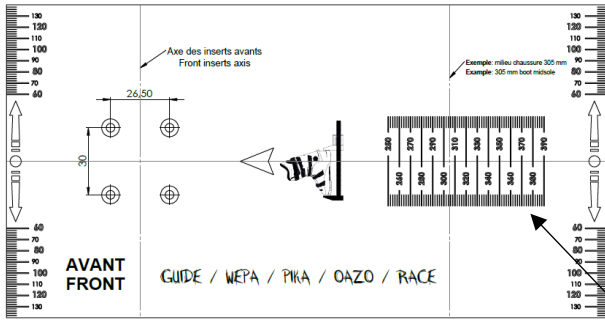

1cm = 1cm

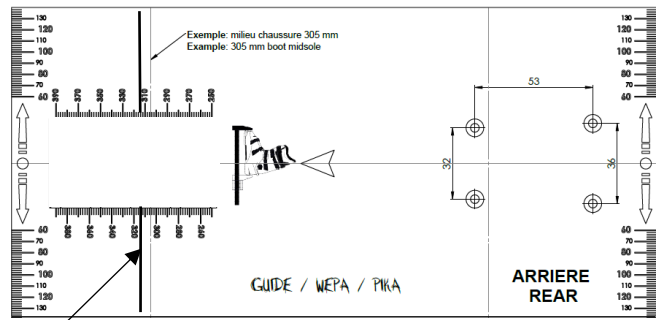
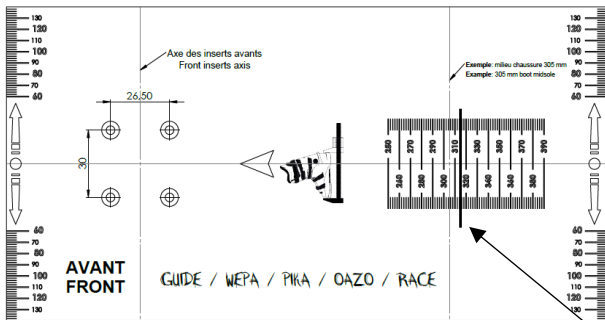
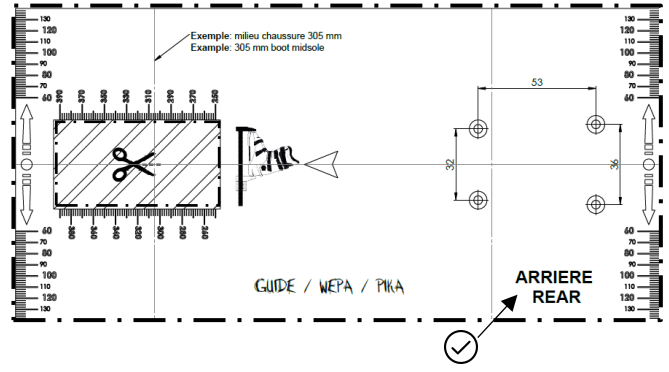
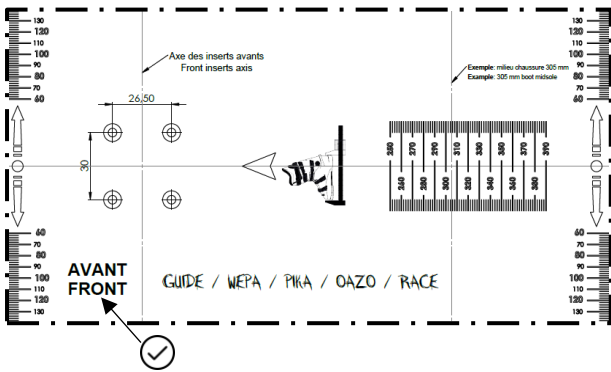
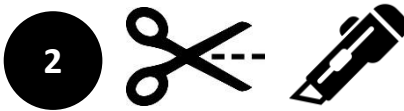

4

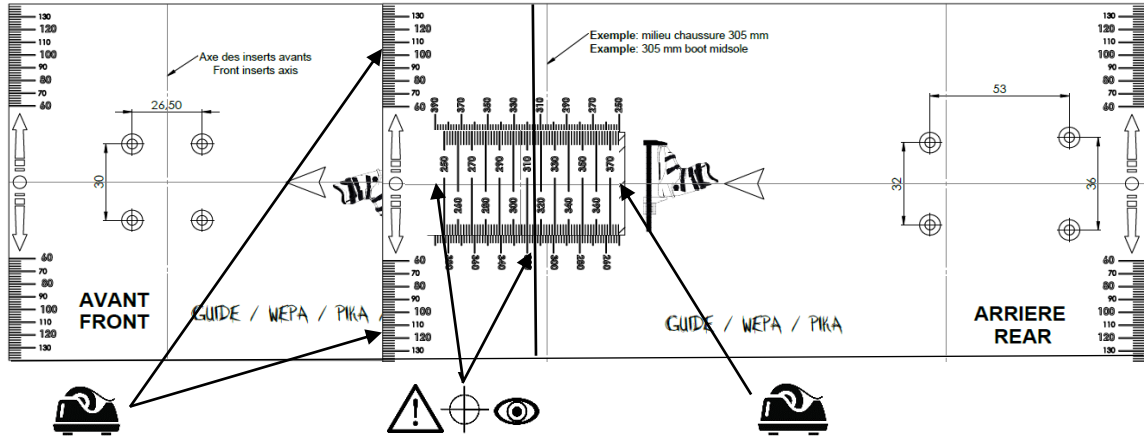
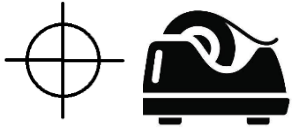

5

